

MISP User Training - General usage of MISP

MISP - Malware Information Sharing Platform & Threat Sharing



CIRCL

Computer Incident
Response Center
Luxembourg

Team CIRCL

<http://www.misp-project.org/>
Twitter: @MISPProject

MISP Training @ Prague
20180917

MISP - VM

- Credentials
 - MISP admin: admin@admin.test/admin
 - SSH: misp/Password1234
- Available at the following location (VirtualBox and VMWare):
 - <https://www.circl.lu/misp-images/latest/>

MISP - General Usage

Plan for this part of the training

- Data model
- Viewing data
- Creating data
- Co-operation
- Distribution
- Exports

MISP - Event (MISP's basic building block)

Event
Creator org
Description
Analysis
Threat level
Distribution

MISP - Event (Attributes, giving meaning to events)

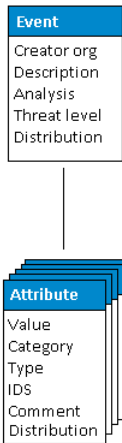

MISP - Event (Correlations on similar attributes)

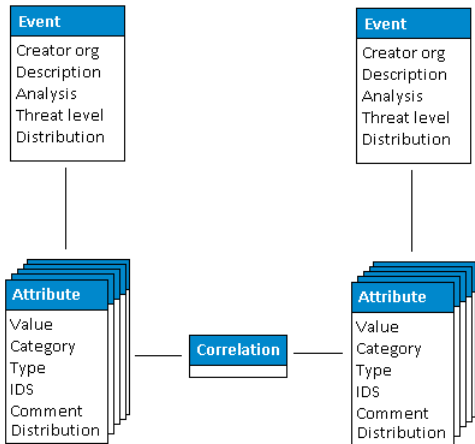

MISP - Event (Proposals)

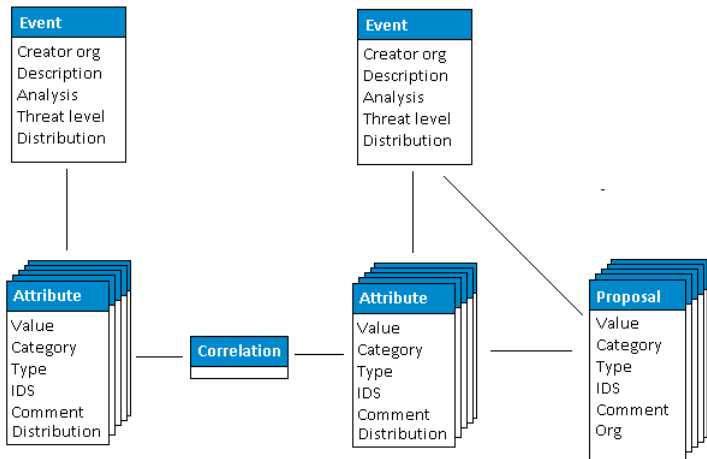

MISP - Event (Tags)

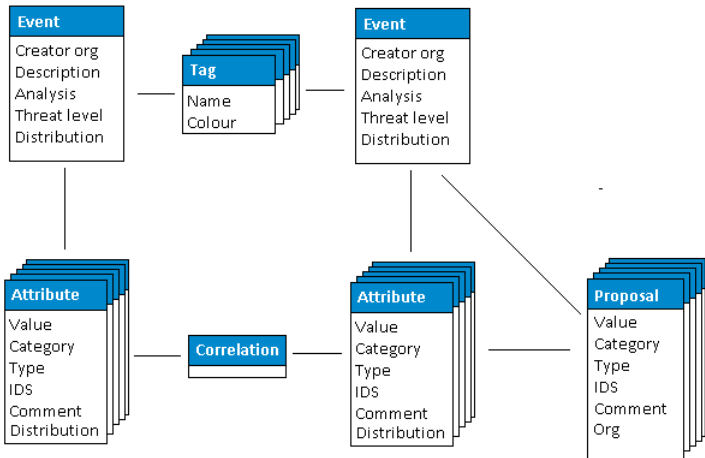

MISP - Event (Discussions)

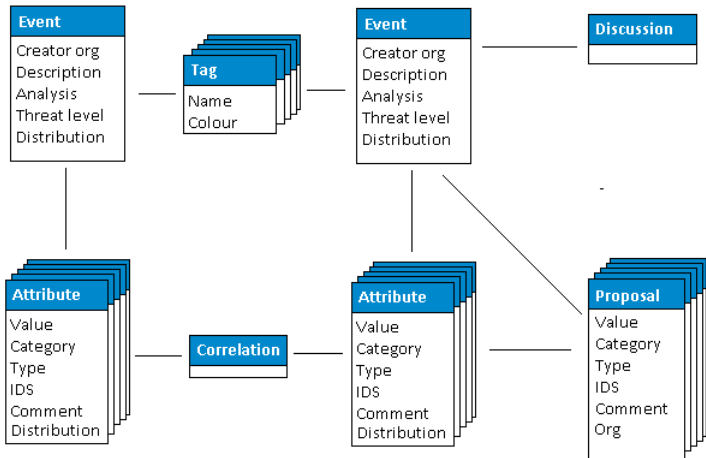

MISP - Event (Taxonomies and proposal correlations)

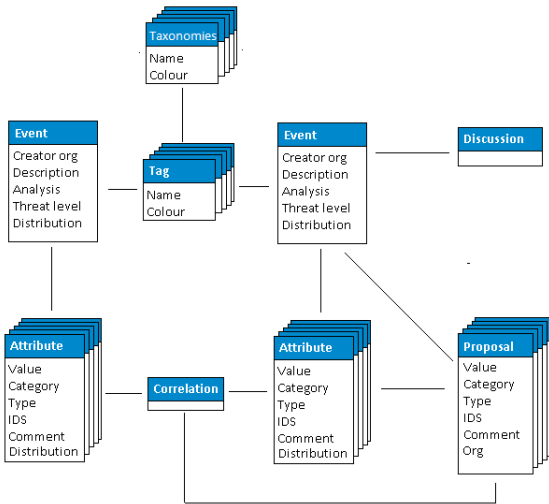

MISP - Event (The state of the art MISP datamodel)

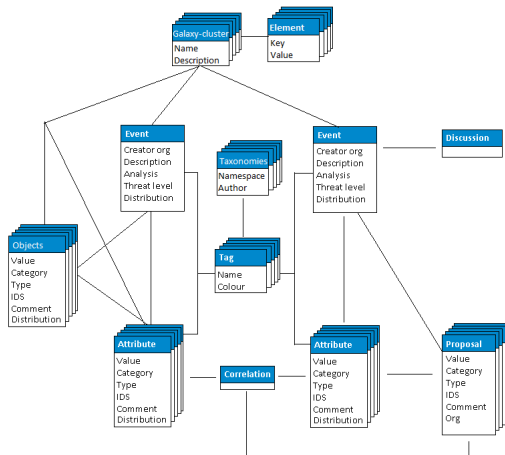

MISP - Viewing the Event Index

- Event Index
 - Event context
 - Tags
 - Distribution
 - Correlations
- Filters

MISP - Viewing an Event

- Event View
 - Event context
 - Attributes
 - Category/type, IDS, Correlations
 - Objects
 - Galaxies
 - Proposals
 - Discussions
- Tools to find what you are looking for
- Correlation graphs

MISP - Creating and populating events in various ways (demo)

- The main tools to populate an event
 - Adding attributes / batch add
 - Adding objects and how the object templates work
 - Freetext import
 - Import
 - Templates
 - Adding attachments / screenshots
 - API

MISP - Various features while adding data

- What happens automatically when adding data?
 - Automatic correlation
 - Input modification via validation and filters (regex)
 - Tagging / Galaxy Clusters
- Various ways to publish data
 - Publish with/without e-mail
 - Publishing via the API
 - Delegation

MISP - Using the data

- Correlation graphs
- Downloading the data in various formats
- Cached exports
- API (explained later)
- Collaborating with users (proposals, discussions, emails)

MISP - Sync explained (if no admin training)

- Sync connections
- Pull/push model
- Previewing instances
- Filtering the sync
- Connection test tool
- Cherry pick mode

MISP - Feeds explained (if no admin training)

- Feed types (MISP, Freetext, CSV)
- Adding/editing feeds
- Previewing feeds
- Local vs Network feeds

MISP - Distributions explained

- Your Organisation Only
- This Community Only
- Connected Communities
- All Communities
- Sharing Group

MISP - Distribution and Topology

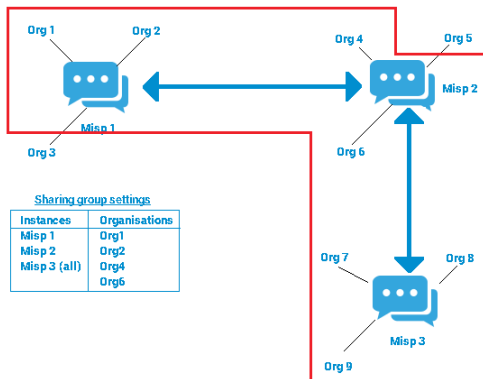

MISP - Exports and API

- Download an event
- Quick glance at the APIs
- Download search results
- Cached exports

MISP - Shorthand admin (if no admin training)

- Settings
- Troubleshooting
- Workers
- Logs